

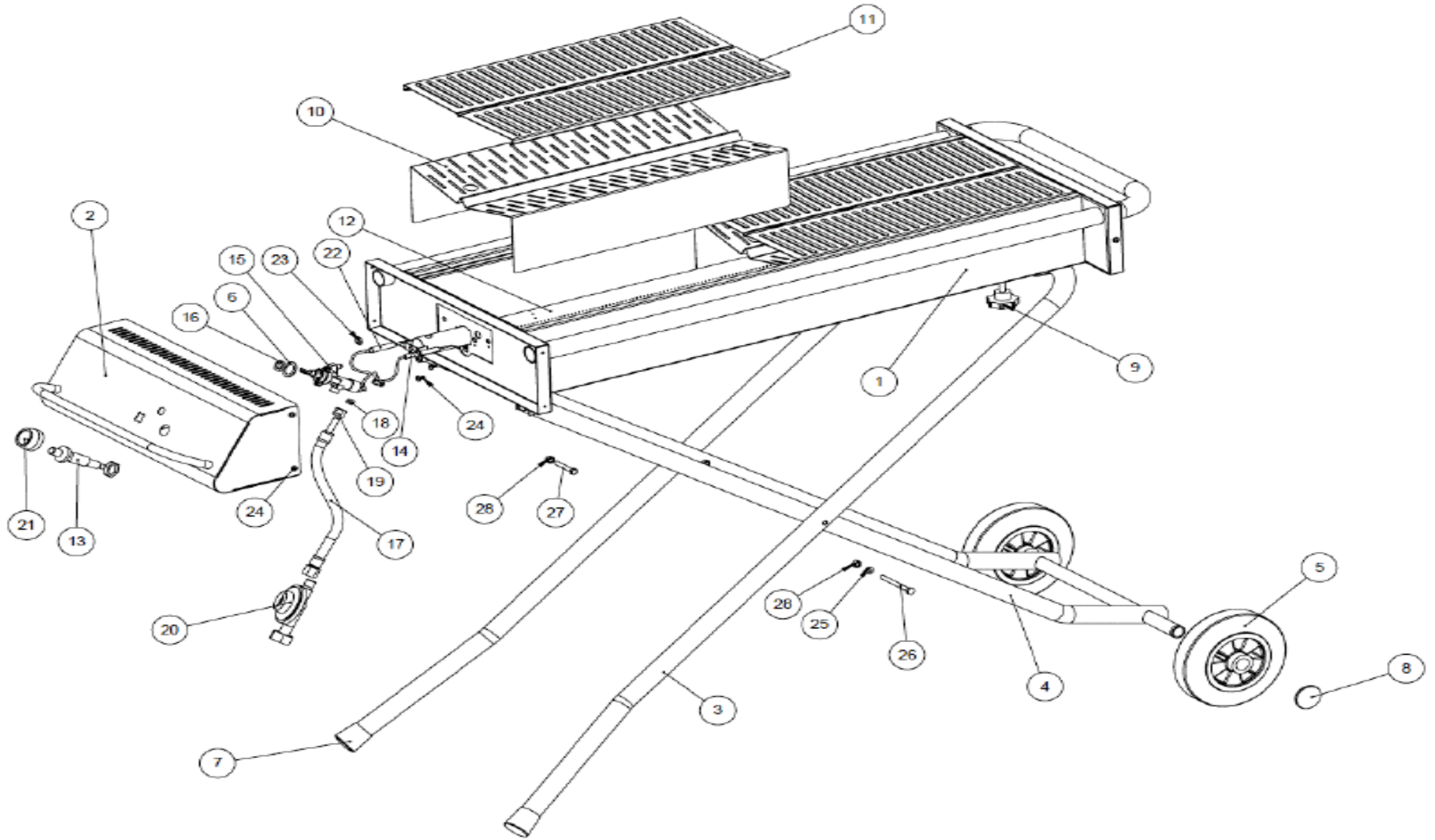

















Exploded diagram and spare parts list – P111 – (215302)



Exploded diagram and spare parts list – P111 – (215302)

Machine	Explode	Code	Description
P111 Buffalo Folding Gas Barbeque	1		Frame
P111 Buffalo Folding Gas Barbeque	2		Display cover
P111 Buffalo Folding Gas Barbeque	3		Tube frame
P111 Buffalo Folding Gas Barbeque	4		Tube frame
P111 Buffalo Folding Gas Barbeque	5	N902	Wheel X 1
P111 Buffalo Folding Gas Barbeque	6		Washer
P111 Buffalo Folding Gas Barbeque	7		Plastic cap 28mm
P111 Buffalo Folding Gas Barbeque	8		Cover/holder
P111 Buffalo Folding Gas Barbeque	9		Bolt M8x20
P111 Buffalo Folding Gas Barbeque	10	AF946	Lower Grill
P111 Buffalo Folding Gas Barbeque	11	N445	Griddle
P111 Buffalo Folding Gas Barbeque	12	N453	Gas burner For Units with Model number 215302
P111 Buffalo Folding Gas Barbeque	12	AG089	Gas burner For Units with Model number 148211
P111 Buffalo Folding Gas Barbeque	13	N447	Piezo igniter
P111 Buffalo Folding Gas Barbeque	14		Electrode with wiring
P111 Buffalo Folding Gas Barbeque	15	N450	Gas valve
P111 Buffalo Folding Gas Barbeque	16		Nut M12x1
P111 Buffalo Folding Gas Barbeque	17	N904	Hose assembly
P111 Buffalo Folding Gas Barbeque	18		Cutting ring 4mm
P111 Buffalo Folding Gas Barbeque	19		Nut M12x1
P111 Buffalo Folding Gas Barbeque	20	N449	Regulator 37mBar UK
P111 Buffalo Folding Gas Barbeque	21	N901	Knob
P111 Buffalo Folding Gas Barbeque	22	N448	Thermo couple
P111 Buffalo Folding Gas Barbeque	23		Hex Nut M8x1
P111 Buffalo Folding Gas Barbeque	24		Sheet metal screw
P111 Buffalo Folding Gas Barbeque	25		Washer M6
P111 Buffalo Folding Gas Barbeque	26		Bolt M6 x 65
P111 Buffalo Folding Gas Barbeque	27		Bolt M6 x 40
P111 Buffalo Folding Gas Barbeque	28		Locknut M6